



Q5er – The Official Newsletter of the Skyview Radio Society



Very few of us are able to build transmitters, receivers, or transceivers from scratch. From kits maybe, but not from scratch. Even building accessories from scratch is getting to be more difficult. However, building antennas from scratch continues to be achievable and a popular pastime. An efficient antenna trumps adding power because it provides a benefit on receiving as well as transmitting. See Charles—KC3TTK's antenna from scratch construction article in this issue.

2024 is Skyview's 64th Anniversary !!

February 1, 2024

- PanCan Coming Up
- RTTY Logging Accuracy
- APRS in WPA - Update
- Skyview VE Sessions
- WearsFest
-
- And More

**Sunspot Numbers
are Way Up
There !!!**

**Time to exercise
the 10-12-15-17-20
Meter bands**

Inside this issue:

FROM THE EDITOR	3
BUSINESS MEETING MINUTES	4
ANTENNA FROM SCRATCH	6
BUILDING YOUR SHACK - PART 1	14
PRACTICAL GUIDE TO VSWR	17
COAX ADAPTERS	25
ULTRA PICOKEYER ISSUES	37
NEW MEMBERS	40
KUL-LINKS	41



The Skyview Radio Society Clubhouse is the “Every Tuesday Place” . . .

Something is going on at ‘the joint’ each and every Tuesday evening, from about 1900 hours to whenever.

See the general schedule of Tuesday events on the Skyview Web Page: <http://www.skyviewradio.net>

For the latest up-to-date plan, check the Groups.io Reflector at : <https://groups.io/g/K3MJW>

Directions are on: <http://www.skyviewradio.net>

Guests are always welcome !!

From the Editor

All types of articles accepted. We do run lots of construction focused articles. However, we are not limited to just those kinds of articles.

We like to see human interest stories that describe some event or activity that you have participated in.

We like to see photo essays , with just a few words describing what we are seeing as well as those with a more detailed story.

Nice crowd at the Annual Skyview Banquet. Always good company and a good meal.

Jody - K3JZD

Remember: The number of people older than you never increases, it only decreases

Ham Radio is a Contact Sport

From the Treasurer

Membership Renewal Time is here once again. Your Membership Dues “keep the lights on”. If you have not done so yet, Renew Now !!!

IMPORTANT : If you included a Donation with your 2024 Dues, and you want a Receipt for that donation, email me at k3jzd AT arrl DOT net and request a receipt. We do not automatically issue receipts because not everyone is able to itemize on their income tax returns

And for you folks with IRAs who are now taking RMDs, remember that making a ‘QCD Donation’ to Skyview lowers your tax bill.

Jody - K3JZD

ADVENTURE: The respectful pursuit of trouble

Continue Use the Skyview Facilities At Your Own Risk - It is Not Really History Yet.

Follow <https://groups.io/g/K3MJW> for COVID updates.

Skyview Radio Society is recognized by the Internal Revenue Service as a charitable non-profit organization under Section 501(c)(3) of the IRS Code. Donations to Skyview are tax deductible to the extent permitted by law.

Support your club.

Some day you will be old enough to start reading fairy tales again. – C.S. Lewis

November Business Meeting Minutes

de Don - WA3HGW

Skyview Radio Society

Monthly Business Meeting – January 2, 2024

Call to Order: 7:30 PM by President Brian Manley, K3ES.

Attending – 29 Members: WA3HGW, AB3ER, NM3A, N3DRB, K3STL, N3WMC, K3FAZ, KC3PXQ, W3IU, KB3DVD, KC3CBQ, N2MA, K4PDF, W3ZVX, AB3GY, K3ES, K3JZD, WA3KFS, AC3IE, AC3KI, AG3U, AG3I, W3UY, K3JAS, N3TIN, AJ3O, AC3GB, KE3IF, WC3O.

Prior Meeting Minutes: The minutes of the December 5, 2023 meeting were distributed for member review. A motion to accept the minutes as presented was made by N3WMC and seconded by NM3A. The motion passed without objection.

Treasurer's Report: Treasurer Jody, K3JZD, reviewed the Financial Report of 31 December 2023 and also provided an email copy outlining end of year financial information (both attached). Income and expenses were normal with income from equipment sales, 50/50 drawing, and VE testing with expenses for restroom remodeling. A motion to accept the Treasurer's Report as presented was made by KC2PXQ and seconded by AC3KI. The motion passed without objection.

Membership Report: Tom, AB3GY, advised there is one membership application. AB3GY made a motion to open the membership rolls, which was seconded by WA3KFS. The application is from: Rich Newbould, K3RWN, an Extra class from Pittsburgh, PA. A motion to accept the nomination was made by AB3GY and seconded by AJ3O. The motion passed without exception. AB3GY made a motion to close the membership rolls,

which was seconded by N3WMC. The motion passed without exception. Membership now stands at 121. Tom noted that 2024 membership renewals are still being received, and reminders will be sent to those who have not renewed their membership.

Radio Officer Report: Bob, WC3O, reports that all radios are in good shape. The computers are set-up for the upcoming RTTY Roundup. He is seeking operators in our effort to repeat last year's win in our Multi-Multi class. Backup power for our backup 2 meter repeater is not working correctly. This will be looked into. The main 146.64 repeater is working well. The last rotor controller damaged by the lightning strike has a bad processor chip. The controller still works to turn the antenna, only the serial port is still not functioning. This will be repaired when the replacement chip arrives.

Kitchen Report: Bob, WC3O, noted the kitchen balance is at \$177 after some excess funds were turned over to the treasury. Kitchen stocks are good.

VE Report: At the December session we had two new Technicians, two General class upgrades and two Amateur Extra class upgrades. Presently there are two scheduled for the next VE session on January 20.

Newsletter: The December issue of the *Q5er* is out. Submissions by January 15 for the February issue.

Facilities: N3TIN reported that wastewater vents are installed and all water lines into the new bathroom are completed.

Building Committee: AG3I reports that the plumbing is 95% complete and HVAC duct work is 50% complete. Most of the electrical supplies are purchased and elec-

Q5er – The Official Newsletter of the Skyview Radio Society

trical rough-in will start soon. Included in the electrical installations will be motion sensor controlled lighting.

Operating Events Recap: Nothing to report this month.

Calendar of Events:

January 6-7 - ARRL RTTY Roundup. David's Diner for breakfast at 9 AM, and the contest starts at 1 PM local time.

January 13 - North American QSO Party CW.

January 13 – Wash 2 meter contest. 7 to 11 PM Local time.

January 20 - North American QSO Party Phone.

January 20 -- Holiday Party.

Winter Field Day – January 27-28.

January 27 – CQ 160 meter contest CW.

Old Business: There was no old business.

New Business: Larry, AB3ER, noted the recent elain from ARRL Atlantic Division Director K3RF to hams in the Atlantic Division regarding a proposed ARRL confidentiality clause for directors to be included in the ARRL constitution. Lively discussions followed with a decision to follow this topic and decide at a later date if, and/or how the club may choose to reply. John, K3STL, noted not all Skyview members are also ARRL members, and it may not be prudent to reply from the club as a whole to this topic.

Weather Night: Steve, K3FAZ, thanked club members for supporting the club weather group in 2023. It's been a good year of enthusiasm and growth. He looks forward to more good things in 2024.

January 9 – Conditions reporting via CoCoRaHS plus ice accretion measurement.

February 13 – Alecia Miller from the National Weather Service in Water Gauge Reading (via ZOOM).

Elmer Night: January 30 by Bob, WC3O – A “National

Talent Surprise Guest”. Don't miss it!

Net Report: Check-in numbers averaged 42.24 in November. Good job from Cousin Joe, KC3PXQ on Net Control on two evenings. If you want to volunteer for net control, contact K3STL or WC3O.

50/50 Drawing: The 50/50 total collected was \$56. The winner of \$28 was Dave, N3DRB, who donated his proceeds to the club treasury.

Meeting Adjourned: A motion to adjourn was made by K3JAS and seconded by AC3KI. The motion passed without objection. The meeting was adjourned at 8:05PM.

Respectfully Submitted,

Don Stewart – WA3HGW

Secretary; Skyview Radio Society, Inc.



Building an Antenna From Scratch

de Charles - KC3TTK

This month's article will not be as technical as last month's article, but it is something I have been working on for a little while and thought it time to share. Though it may be completely finished, I think there will always be room for improvements. This might end up being a long-term project as I gain more experience and learn what works well and what doesn't.

In the coming months I would like to do some portable ops. Maybe POTA, SOTA or perhaps just sitting in a field somewhere just to be outside. Any of these portable outdoor activities will require some of the same hardware.

This is where I decided that I wanted to build an antenna. Just like everything else in this hobby, the best way for me to learn is by doing. I can read articles, listen to opinions, and watch YouTube videos until I find the end of the internet. I have done a lot of this. I have watched, read and listened.

Now it is time to do something. There were a lot of nice antenna setups that people have for sale and that people have made. I could buy a Chameleon CHA PRV POTA, a Buddistick pro deluxe, or any other number of kits and I am sure they are great antennas with outstanding results. But where is the fun in that. I know there is an old saying "buy once cry once" when it comes to, well just about anything. But this is not the route that I have taken on this project.

My Design Parameters were:

- Multi band operation
- Fits inside of a 1500 Pelican case
- No tools for assembly or disassembly

I also wanted to repurpose some items I had laying around.

After a little bit of research I decided to go with a Wolf River style coil. It seemed easy enough to build and I had almost everything on hand. The only thing I had to buy was a "pipe riser" from Ebay for about 25 dollars.

It is a 12 inch piece of 1.5 inch pipe with external threads along its entire length. The riser also came with the two

end caps. Good thing too – because it was BSP threads not NPT. I would have had a crummy time trying to find the right end caps.

The end caps each got a bolt inserted into them 3/8-24 which accommodates most antennas.

The pipe was wrapped with 14 AWG galvanized steel wire, which was on hand.

Here is the wrapping process



(The spool holder was readily available)

Here is my completed coil



There is a total of approximately 16 meters of wire wrapped around the pipe to form the coil.

Looking at the T bolt clamp I replaced the hex nut with a wing nut to make it easier to adjust the coil

The pipe is 1.9 inches in diameter and there are 112 turns. This worked out to roughly 16 meters.

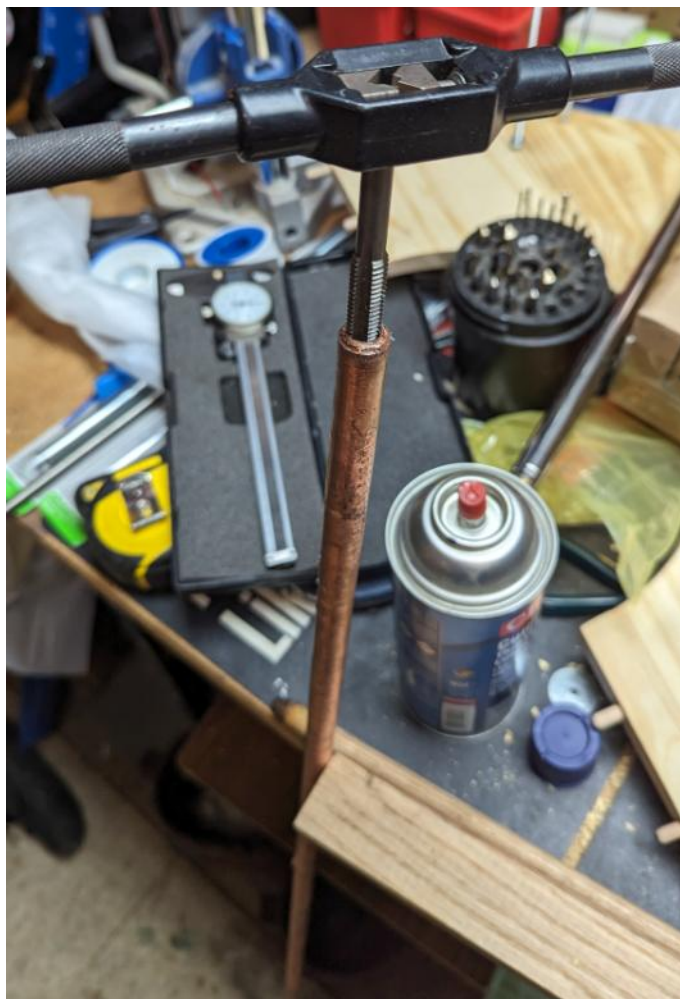
One thing I did learn doing this though, is that a Wolf River coil is reasonably priced. If I would have had to purchase all of the materials needed to build this coil, and not accounting for my time, it would have been comparable to purchasing the Wolf River Silver Bullet 1000 which is designed for 80 to 100 meters. That Wolf River coil is currently selling for \$75. So its good to know that they are charging a competitive price for their product.

The next consideration was the radial and ground setup. I had a couple pieces of ground rod laying around. Each piece of ground rod is approximately 22 inches in length. This length was chosen because of the size of the case I wanted the antenna to fit in.



Two pieces of these were drilled and tapped to 3/8-24. One piece of ground rod was shaped to a point. This provides both support for the antenna and a good ground. The other piece goes between the feed point and the coil.

Since the highest current in the antenna is at the feed point, I thought that adding some space between the feed point and the coil could reduce the heating of the coil.



As far as the radials, this ended up working out very well. I used a 3 inch PVC cleanout and a cap. The cap fit over-top of the cleanout perfectly.

For connecting the radial wires, I used RCA connectors that I had from another project. I soldered them together using a piece of 12 AWG wire.

This also is where the feed point is located.

There is a bolt through the top and bottom of the assembly to allow connecting it to the ground rod and the coil.

Q5er – The Official Newsletter of the Skyview Radio Society

Here is a picture of the inside of the PVC pipe showing the design of the feed point and the radial ring.



Here is an image of (some of) the radials connected



As for the actual antenna I picked up two different inexpensive antennas. Though it looks like (as I will elaborate on) I made a mistake here but I will get into that in a moment. The antennas I picked up were a 5.8 meter telescopic whip antenna and a 2.85 meter 7 segment whip antenna.



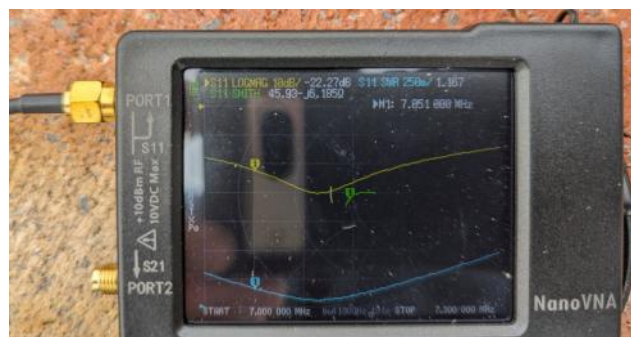
The 5.8 meter whip when extended was a bit unstable. I put together a system of parachute cord, and cord tensioners to keep the whip stable when fully extended. (hence the pipe clamp with cord attached to it. This is where the lengths of cord attach to keep the antenna steady)

The smaller antenna stood without issue and was rigid enough that I felt like it could be left up without issue.

Now for the tuning.

The 5.8 meter whip, I could adjust it to get a pretty decent SWR on 40 and 80 meters. I did not have much luck with 20 meters or lower, even by adjusting the length of the physical antenna. Though I think I might have been doing it wrong. This is a work in progress, so I am going to try again very soon. I think that by purchasing such a long whip I really made things overly complicated for myself both from a structural standpoint, since I had to add guy ropes, and from a tuning standpoint. Because I could not really dial in anything lower than 40 meters.

Here is the NanoVNA on 40 meters. The SWR curve was better than I expected. When connected to the ICOM, the internal auto tuner did not have to work very hard to get the SWR down to 1:1



The results on 80 were not quite as good as 40, but I was still able to get a good SWR right in the middle of 80 meters



The 2.85 meter whip was perfect for 20 meters. I did not try to tune any frequencies higher than 20 meters for this antenna. As the length cannot be adjusted.



I checked the SWR on the ICOM after a quick autotune and it was pretty flat across 20 meters. I was really happy with this



It actually tuned up a little different than my permanent antenna :



Here is a list of parts I used. Most everything I had on hand. All I had to buy for this project was the PVC pipe, the pipe risers and the two whip antennas.

- Pelican Case
- 12 inch pipe riser with caps
- 2 inch T Bolt hose clamp
- 60 feet 14 awg galvanized wire
- 18 inches of 14 awg wire (for the pickup on the coil)
- 8 X 30 foot pieces of 14 to 18 AWG wire (whatever you can scrounge up – Wire is expensive these days)
- 5.8 meter telescopic whip Antenna
- 2.85 meter 7 segment collapsible whip antenna
- 4 x 3/8-24 bolt 1.5 inches long
- 8 x 3/8-24 nuts
- 3/8-24 coupling nuts
- 5/8 inch ground rod
- 3 inch PVC Cleanout with cap
- 3 inch PVC domed cap
- 8 x panel mount RCA jacks
- 8 x RCA plugs
- Several Ring terminals (1 for the T bolt clamp, 4 larger ones for the 3/8 bolts)
- ¼-28 wing nut
- 4x 25 feet parachute cord
- 4 x cord tensioners
- 4 x tent stakes
- 1 x 1 inch worm gear pipe clamp
- 4 x carabiners

Here are a couple images of the antennas up in my yard



So, What is the Verdict?

Well – I have not taken it into the field yet, and the yard at my house is not the ideal place for a ground mounted vertical antenna. But in my few attempts to use the antenna I made 10 or so QSOs on 20 meters and 5 on 40 meters. Not bad for only using it once or twice since I finished it.

I would like to take it neck and neck with a Chameleon or someone using a wolf river coil just to compare performance in the same location if anyone is interested.

If anyone has any suggestions for anything I can do to improve my setup please feel free to reach out. I am always open to new ideas and new ways of looking at my projects.

As always thank you for reading

de Charles - KC3TTK

APRS in WPA Experience— Update

de Jody - K3JZD

My APRS experience article in the December 2023 newsletter got some attention. Whenever the WPA APRS gurus investigated my poor APRS results, they found some latent APRS monitoring station problems. So, that was a good thing.

And whenever Curt - WU3U made a special trip to come out and drive a route through my usual local travel area, he was tracked quite well by APRS. Even in some valleys. Subsequent advise from Curt and the others suggested that my 5 watt radio and my stubby compromise rooftop antenna was simply not going to cut it in WPA. It seems that most use a 50 watt radio and a better antenna for WPA APRS.

First I tried raising my power to 20 watts (the maximum that my small tracking-only mobile radio will produce) instead of 5 watts. That did not make any real difference. Next I tried changing my beacon interval from every 3 minutes to every 2 minutes to see if it improved the odds of me being heard whenever I was in higher locations. That did not make any real difference either. (This inexpensive radio will not do 'Smart Beaconsing').

Then I put a ¼ wave mag mount on my hood as an experiment. I could not put it on my SUV's roof because it would take out the windows in my raised garage door whenever I pulled into my garage. While on the hood is far from an ideal location for a ¼ wave mag mount, that antenna change made a difference. I was now being tracked locally much better with my 20w APRS radio and 2 minute beacons. There were gaps, but at least I was now leaving a tail.

I'm not willing to commit the funds needed to put a 50w APRS radio into that vehicle. And I do not want to deal with the 12v power wiring that would be required to support a 50w radio. So, I'm just going to stick with using my small 20 watt radio. I did mount an on-glass antenna onto a side window of my SUV, mounting it as high as possible without having it hitting my raised garage door. While that is once again a compromise over having a ¼ wave centered on the roof, it seems to work just as well as my having a ¼ wave mag mount on my hood did.

And I also changed my beacon interval to every 60 seconds to further improve the odds of my being heard. If that turns out to be overloading the APRS network, I will go back to using a 120 second interval. And I discovered that the firmware in my inexpensive Radioddity DB25-D radio cannot deal with scanning Voice Repeaters whenever I'm expecting to be tracked by APRS – it needs to be dedicated to doing APRS beaconing only. But that is a limitation of my inexpensive radio.

What I'm now finding is that I'm now being tracking better in the WPA area. Still have some large gaps, but I'm at least leaving a tail. But, on my one trip to South Butler using my latest set up, I was only tracked as far as Gibsonia. I was not seen once I was to the North of Gibsonia. But that is with my 20 watt radio. Maybe a 50 watt radio would do much better in that area. A recent trip to Conneaut Lake, PA had large gaps but monitoring stations in Ohio spotted me at my destination (it is very flat up that way).

The bottom line is: If you want to use APRS in the hills of WPA, you really need a 50w or greater APRS radio and at least a ¼ wave 2m antenna. Especially if you want to do any APRS messaging.

de Jody - K3JZD



My Small Radioddity DB25-D 20 Watt APRS Radio

(That is the whole radio—not a removable faceplate)

Skyview VE Sessions

Skyview provides VE Testing at the Skyview Clubhouse each month (Details provided later, near the end of this newsletter)

Here are some of the recent success stories

December 2023

Eric Evans KC3YES passed the Technician exam

James Palumbo KC3UOM passed the Extra exam

Wes Zambo KC3VUO passed the General exam

Brian Anthony KC3YEO passed the Technician exam

Michael Kosalko N3ARA passed the Extra exam

Paul Barbour KC3WHX passed the General exam

January 2024

Testing Session Cancelled

Due to Hazardous Conditions



SILENT KEY

Thomas R Whitby - KC3SKX
Delmont PA

tnx : Bill - N3WMC

Hams and Their Ham Shacks

de Jody - K3JZD

Where did the term 'Ham Shack' come from anyway? I'm sure that if you search the Internet long enough, you will come up with several plausible answers. But, just like searching to find out where the term 'Ham Radio' originated, I think that at the end of the day you will have more conflicting answers that you wanted.



Ham Shack - Outside

So, for our purposes, let's just define a 'Ham Shack' as being the place in your home where you place your ham radio equipment and operate from. Sometimes, especially when you are new to the hobby, it may be very modest and in some very inconspicuous location. Or perhaps it is in a stealth location like a closet or a roll top desk where the equipment can be totally hidden whenever it is not in use. Or maybe built into a wall arrangement where it can blend in with the shelving and hide behind closed doors.

After being in the hobby for a while, and seeing what others have done, many will seek a larger area to use for their Ham Shack. Spare bedrooms or other primary living areas are sometimes used. But it seems like more often than not, one will commandeer a corner of the basement, or build a dedicated room in the basement to setup their Ham Shack. The basement often gets chosen because a spouse will usually agree to giving you a portion of the basement much sooner than agreeing to give you space in any other part of their your house.

Ham Shacks often will expand and become quite elaborate. Many will grow to become the equivalent of what a trophy room is to a game hunter. Many of us have a way of hanging on to radios after we have upgraded to a new radio because once in a while it is still fun to use the older radio(s) that we have enjoyed for so long. So we need 'space'. And then more 'space'.



Ham Shack - Inside

I have frequently solicited pictures of Ham Shacks to publish in the newsletter. I will accept them with or without an accompanying article that describes the Ham Shack building experience and/or features. I always welcome any Ham Shack pictures.

This month, Bill - NY3H sent me a 20 page article describing his personal experiences with building his multiple Ham Shacks over the years. Bill has a lot of good experience to share. I am going to divide Bill's article and run it as a multipart series over the next several issues of this newsletter. Part 1 follows.

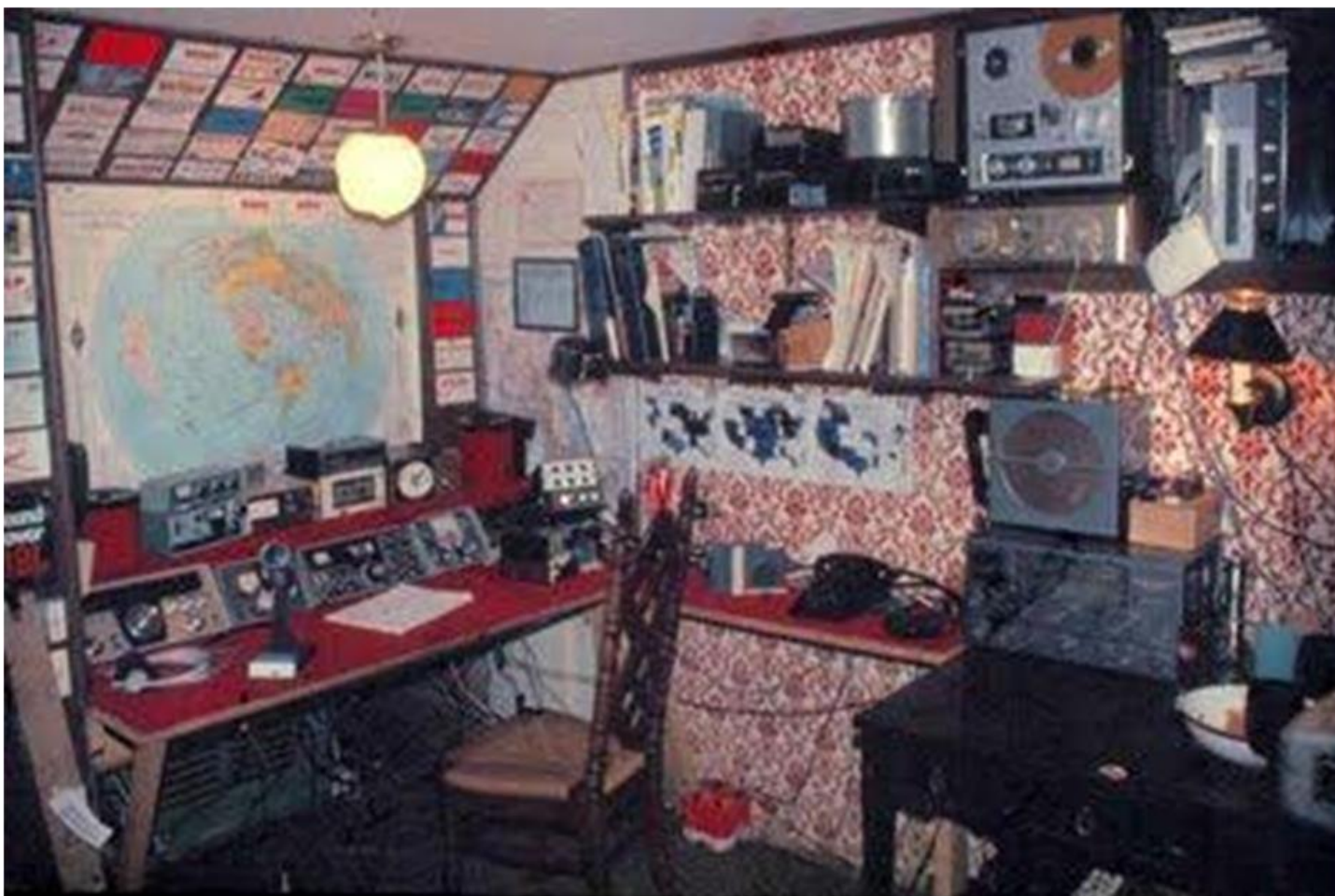
Jody - K3JZD

BUILDING YOUR SHACK - Part 1
(OR HOW NOT TO BE RELEGATED TO THE BASEMENT)

de Bill - NY9H

Many amateurs are willing to spend hundreds or thousands on their hobby, yet apparently make no effort to make it nice enough in appearance. It's no wonder many are relegated to the basement.

My first shack, while situated in the relatively unfinished basement, did have a finished feel to it. This is a journey through my efforts to provide a custom finished console for my station.



Total cost for several 2x4s and some shelving particle board, probably was under \$25..and the red rug was free !! I had very little space available, thus my "shack" was in-conveniently built up against the gas furnace. Looking carefully you can see the green grill below the desk. Thankfully no furnace servicing was necessary ! (overall a poor design).

Considerations included trying to provided both proper shelf heights and a tilted shelf for the radios and providing a proper viewing angle. If radios are just sitting on a shelf, sometimes it provides an poor angle for both operating and knob turning. Height of the work surface must have your forearm just resting on the surface for easy tuning and adjusting radios as well as operating your CW paddle. The shelf depth or size of your table top is critical. There must be at least 10 to 12 inches depth in front of your radio for your arms, paper-

The 'rig' was a Yaesu FT-101, which used tv "sweep tubes" in the final amplifier, the balance of the radio was transistorized. Left of center was the 'matching' VFO, as in the 70s, rigs did NOT have the capability of going 'split' without an external VFO.

The Allied AX-190 on the far left was configured to provide a second receiver, for chasing split DX.

On the right is a British KW combo ...antenna match (tuner) / Dummy Load / SWR bridge.....

On the top shelf is the QRP Heathkit HW-7, with an autopatch telephone interface box on top, then my antenna rotor controller, digital freq readout for the Yaesu , a front facing speaker and an AC line voltage meter.

Microphone was a Shure 444... still a great microphone choice.

Next is the Regency HR-2 two meter radio & the very famous GLB synthesizer which not only provided all two meter frequencies for the normal crystal radio set, but provided a sort of 'spread spectrum' of noise across two meters.

A pair of 13 element 2 meter beams atop the tower added 13DBid of gain.

Less than 60 countries were confirmed from this station, but no effort had gone into chasing DX, (YET)

40 years ago , there is card on the wall for W9VBV, now friend Bill Smith W9VA.

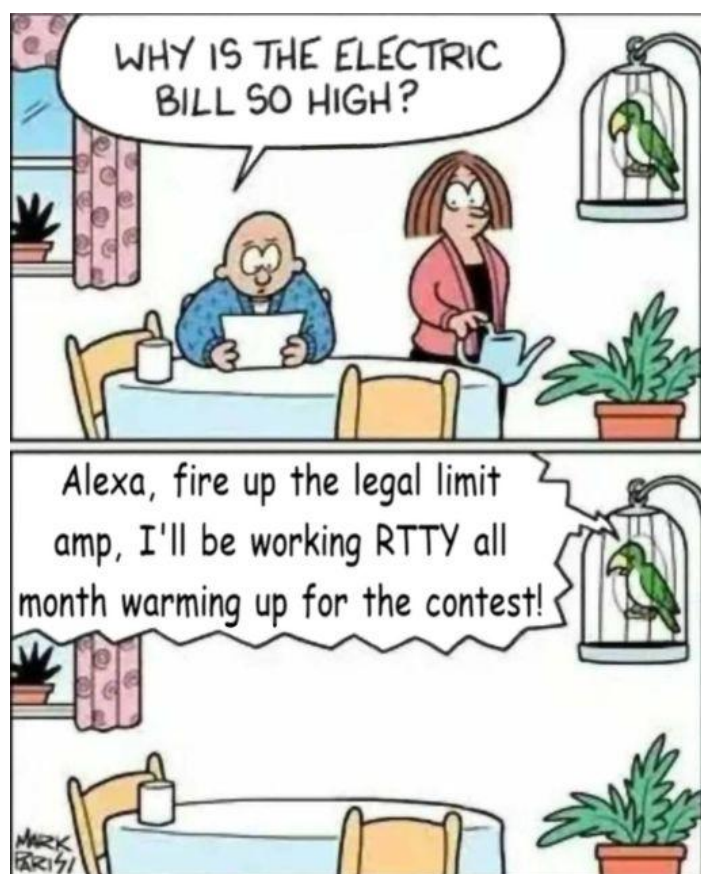
And then I moved in 1979... and I got to do it all over again ,

Things got better and I got upstairs !!!!

Tune in next month for the next installment of this continuing story

de Bill - NY9H

Most people
are lucky
they can't
hear what
I'm thinking.



VSWR (Voltage Standing Wave Ratio, or alternately just SWR) is a value that many hams focus on, but few **really** understand its implications. A recent exchange on the Skyview reflector brought up a number of SWR topics, with varying degrees of rigor and explanation in the responses. Perhaps the clearest takeaway from the discussion was that a good review is in order. There are of course plenty of treatises on this subject, from engineering textbooks to ARRL articles and handbooks. Most do an extremely deep dive, with math from trigonometry to calculus required, along with complex variables, and usually a section or two involving the Smith chart. The challenge with those approaches is that it is hard to develop an intuitive feel for what's going on, so that one can make good setup decisions. Even though a few formula derivations will be done here, the intent is to provide what could be called a practical guide to SWR – requiring only basic algebra, with only a mention of complex numbers when absolutely necessary for completeness.

Let's start with a glossary of a few symbols and terms that will be needed throughout this article.

- Z_0** The characteristic impedance of the cable (*i.e.* coax, ladder line, twisted pair etc.) being used
- Z_L** The impedance at the “load” end of the cable (*e.g.* an antenna or dummy load)
- V_{IN}** The voltage amplitude of the wave traveling from the “source” (*e.g.* amplifier, transceiver) to the load (incident wave)
- V_{REF}** The voltage amplitude of the wave traveling from the load to the source (reflected wave)
- I_{IN}** The current amplitude of the wave traveling from the source to the load (incident wave)
- I_{REF}** The current amplitude of the wave traveling from the load to the source (reflected wave)
- SWR** For brevity, SWR will be used for VSWR, and is defined as the ratio of peak voltage amplitude along the cable to the minimum voltage amplitude along the cable
- Γ** At any interface where there is a change in impedance, the reflection coefficient, Γ , is the voltage ratio of the reflected wave to the forward wave, that is, V_{REF} / V_{IN}
- A_p** The power gain ($A_p > 1$) or loss ($A_p < 1$) due to an element, such as an amplifier or a cable, defined as Power Out / Power In. For cable losses, this will often be given as dB / 100 ft at a given frequency.

Before delving into mathematical abstractions, let's make sure we are all on the same page regarding characteristic impedance (Z_0) of a cable (or more properly, a transmission line.) To a time varying signal, a cable appears as a nearly fixed impedance to the source. That impedance is dependent upon the properties of the cable, predominantly the inductance and capacitance per unit length, and has little relation to the DC resistance of the conductors making up the cable. While Z_0 can in general be a complex value, for many real world cables, it is often a good approximation to use a purely real value such as 50Ω for many types of coax. Also in general, the value can vary with frequency, although this effect is usually quite small for the frequencies that hams care about. I will not show how Z_0 is calculated, as that does involve some advanced math; if someone is curious, please contact me and I'll go through it. Suffice it to say, a given cable will have a specified Z_0 , and that is really all you will need for practical matters. Another critical property of a transmission line that I won't prove here is its ability to transmit a signal – a voltage and current wave – along its length. The signals can go either way; the wave front can move forward (often called the incident wave), or in the reverse direction (often call the reflected wave). Interestingly, both incident and reflected waves can be traveling at the same time on a single cable.

Z_L , the load impedance, terminates a cable. It may be a dummy load with a simple fixed real resistance, often 50Ω , or it may be an antenna that has a complex impedance, highly dependent upon frequency. If you want to measure a complex impedance, you can use specialized instruments, such as a VNA (vector network analyzer) or an impedance bridge.

However, as you'll soon see, we often don't need to know the exact complex values to make useful characterizations of our shack setups; we can use more readily available and easier to use measurements such as SWR. The derivations leading up to SWR are shown to help you get the complete picture, but you need not follow every step if you just wish to apply the key results; the formulas shown in **boldface**.

When a wave traveling down a transmission line encounters a change in impedance, the wave will split into a transmitted portion continuing "onward" (or radiated or dissipated if it is a terminal impedance), and a reflected portion, headed back to the source. This is exactly analogous to light hitting a glass pane, where the index of refraction changes from air to glass. Some of the light is reflected back, and some continues through. Note that in the case of a pane of glass, there is a secondary transmission and reflection as the light exits at the "back" surface of the glass.

How to Derive SWR

To get started let's figure out how much of a source wave in a transmission line is reflected from a termination (or load). First the basics – the current and voltage in the transmission line are related by the characteristic impedance (*i.e.* Ohm's law). This applies to the wave going forward (incident), and going backward (reflected). The first two equations are simply the relationship between voltage and current for waves on a transmission line:

$$V_{IN} / Z_0 = I_{IN} \text{ (Eq 1, forward wave Ohm's law)}$$

$$V_{REF} / Z_0 = I_{REF} \text{ (Eq 2, reflected wave Ohm's law)}$$

At any given point in the line, the total voltage is the sum of the two waves:

$$V = V_{IN} + V_{REF} \text{ (Eq 3)}$$

The total net current at any point in the line is the difference of the forward and reflected currents (remember, current has a direction, so think of any reflected current as offsetting the forward current):

$$I = I_{IN} - I_{REF} \text{ (Eq 4)}$$

Substituting Eqs 1 and 2 into 4, we get:

$$I = V_{IN} / Z_0 - V_{REF} / Z_0 = (V_{IN} - V_{REF}) / Z_0 \text{ (Eq 5)}$$

At the load, Ohm's law must also apply to the total voltage and total current:

$$V / I = Z_L \text{ (Eq 6)}$$

Let's use Eqs 3 and 5 to substitute for V and I in Eq 6:

$$(V_{IN} + V_{REF}) / [(V_{IN} - V_{REF}) / Z_0] = Z_L \text{ (Eq 7)}$$

Now let's use the definition of $\Gamma = V_{REF} / V_{IN}$ rearranged slightly:

$$V_{REF} = \Gamma * V_{IN} \text{ (Eq 8)}$$

Subbing Eq 8 in to Eq 7:

$$(V_{IN} + \Gamma * V_{IN}) / [(V_{IN} - \Gamma * V_{IN}) / Z_0] = Z_L \text{ (Eq 9)}$$

Notice that we can divide out all of the V_{IN} terms on the left side:

$$(1 + \Gamma) / [(1 - \Gamma) / Z_0] = Z_L \text{ (Eq 10)}$$

Bring Z_0 up to the numerator, and multiply both sides by the denominator:

$$Z_0 + Z_0 * \Gamma = Z_L - Z_L * \Gamma \text{ (Eq 11)}$$

Put all the Γ terms on the left and non Γ terms on the right:

$$(Z_L + Z_0) * \Gamma = Z_L - Z_0 \text{ (Eq 12)}$$

Finally, dividing to get Γ :

$$\Gamma = (Z_L - Z_0) / (Z_L + Z_0) \text{ (Eq 13)}$$

At the risk of being pedantic, I showed the steps so that you can gain a better insight of what's really happening in the cable. That derivation is the about the most complicated one we'll do; even if you prefer to skip the steps, Eq 13 is the important result. It allows us to determine a reflection if we know the load and line impedances. There are 3 important cases:

- 1) Load impedance equal line impedance: The numerator is zero, so there is no reflection. This is called **matched**.
- 2) Load impedance is infinite (an open): The numerator and denominator both go to positive infinity, and the reflection coefficient is +1.
- 3) Load impedance is zero (shorted): Reflection coefficient is -1.

We'll revisit these cases once we have SWR derived. Note that Γ can in general be a complex number, since either or both of the line and load impedances can be complex. What, you might ask, does a complex reflection coefficient mean? It means that not only will there be a reflected wave with the amplitude given by the magnitude of Γ , but the wave will also have a phase shift compared to the incident wave. Thankfully, all of our formulas after this point will only rely on the magnitude of Γ (depicted as $|\Gamma|$). If Γ is purely real, then $|\Gamma|$ is just the absolute value of Γ . For a complex Γ , the magnitude is the square root of the sum of the squares of the real and imaginary components. The phase of a complex Γ matters if you are matching loads, but our tuners (really, matchers) deal with that detail, as Charles, KC3TTK, pointed out in his recent article.

Now that we have Γ , how do we determine SWR? Here is an easy approach that will help you recall the formula readily. Suppose you have a forward traveling wave of amplitude 1V on an ideal line with no losses. The amplitude of the reflected wave will be:

$$|\Gamma| * 1V.$$

Now consider the resulting standing wave from that forward and reverse wave. The peak value will be the sum of the two amplitudes or:

$$1V + |\Gamma| * 1V \text{ (Eq 14)}$$

The minimum value will be the difference of the two amplitudes or:

$$1V - |\Gamma| * 1V \text{ (Eq 15)}$$

Recall that SWR is defined as the peak amplitude along the line divided by the minimum – in other words, Eq 14 divided by Eq 15. Note that all of the V terms divide out, yielding:

$$\text{SWR} = (1 + |\Gamma|) / (1 - |\Gamma|) \text{ (Eq 16)}$$

You can convince yourself that this simple approach is valid since any voltage used would divide out just the same; V was just convenient. Let's revisit the three reflection cases from before, but now in terms of SWR.

- 1) Load impedance equals the line impedance (matched): Γ is 0, so Eq 16 for $\text{SWR} = 1$. Of course this is usually written as 1:1 so that you remember it is a ratio. However, we'll just use the single number notation.
- 2) Load impedance is infinite (an open): Γ is +1, so $|\Gamma|$ is also +1. $\text{SWR} = +\infty$. The plus really isn't needed – all SWR values are positive.
- 3) Load impedance is zero (shorted): Γ is -1, but $|\Gamma|$ is still +1. $\text{SWR} = +\infty$. Same as the open case. By its definition, SWR is a normalized value – in the end a good thing, since it lets us do calculations that are useful without worrying about pesky complex numbers and phases.

What if we want to convert SWR back to $|\Gamma|$? This turns out to be useful later on. I'll leave the steps to the reader; they are fairly straightforward, and you can use the same "trick" as was used to derive SWR from Γ .

$$|\Gamma| = (\text{SWR} - 1) / (\text{SWR} + 1) \text{ (Eq 17)}$$

Transmitted and Reflected Power

One immediate use of SWR is to understand how much power is transmitted and reflected at a termination, when SWR is not equal to 1. Recalling that Γ is a voltage ratio for the reflected wave compared to the incident wave, if we instead want to get the reflected power, we can square Γ , (remember that power goes as Voltage squared). So, at an antenna that presents a given SWR at its feed-point (the antenna connector), the power reflected (P_{REF}) is Eq 17 squared times the incident power (P_{IN}):

$$P_{\text{REF}} = P_{\text{IN}} * [(\text{SWR} - 1) / (\text{SWR} + 1)]^2 \text{ (Eq 18)}$$

Energy is conserved, so whatever is not reflected is transmitted (or radiated, P_{RAD}).

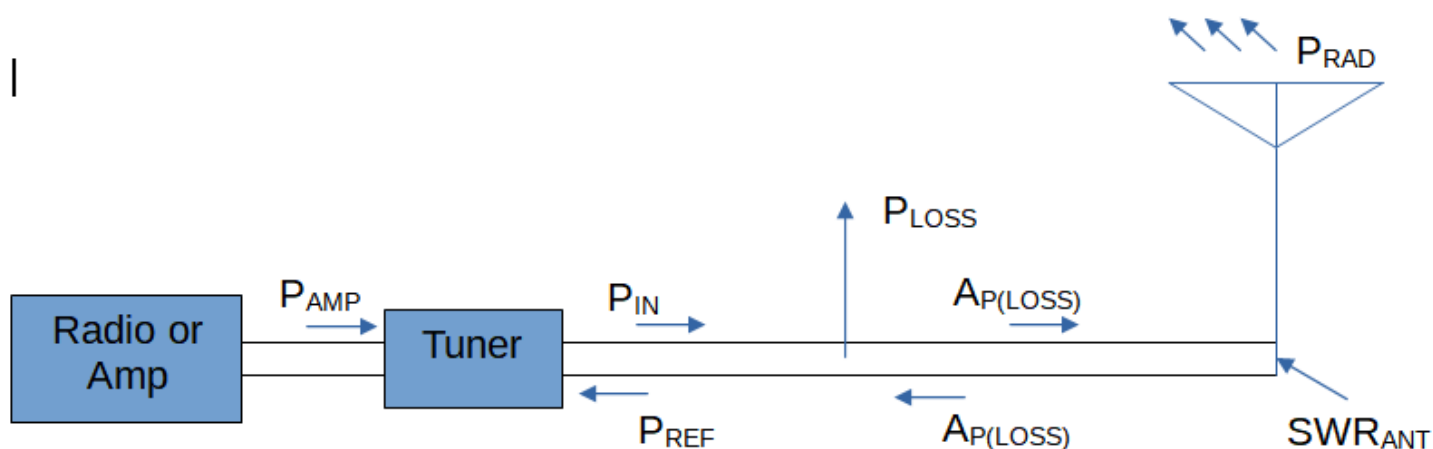
$$P_{\text{RAD}} = P_{\text{IN}} * \{1 - [(\text{SWR} - 1) / (\text{SWR} + 1)]^2\} \text{ (Eq 19)}$$

Let's say you have 100 Watts incident arriving at your antenna connector, and the antenna has an SWR of 5. By Eq 18, 44.4 W will be reflected, and by Eq 19, 55.5 W will be radiated. You can find plenty of tables online or in ARRL manuals that give tables for this, but the formula is essentially as simple to use as looking the value up in a table.

It is very important to understand the interpretation of incident power here. In real life, it will be power supplied by the radio or amplifier, in addition to reflected power that makes a round trip from the antenna, to the radio or amplifier, back to the antenna. Eqs 18 and 19 must be carefully used on the overall incident power at the antenna feed-point. This is what we will now consider.

Calculating Real World Radiated Power

In the real world, cables have losses, and the waves traveling back and forth will have energy dissipated by the cable. Let's diagram a typical setup, and then figure out how well it works.



Let's first describe subjectively what is going in this figure. The Radio or Amp produces a total power output of P_{AMP} , and feeds it to the Tuner (really a matching network) which we will assume does a perfect match to the feed-line/antenna combination, for the frequency being used. Later on, we can consider the case where that input match is not perfect. The signal just past the tuner is P_{IN} , the incident power, which then goes down the cable to the antenna, and gives up some power to heat due to losses in the cable. At the antenna, the power that reaches the feed-point is partially radiated (P_{RAD}) and partially reflected back toward the tuner. The reflected signal is also attenuated due to cable losses. The first surprise is that P_{IN} is usually greater than P_{AMP} . This counter-intuitive result is due to the Tuner doing its job providing a perfect match. All energy from the Radio/Amp makes it through the Tuner **plus** the reflected power that comes back from the antenna. What really happens behind the scenes is that the signal makes one or more round trips in order to build up to that steady state condition. The derivation below is for the steady state result, not the transients of those back-and-forth waves that are occurring on the line. The steady state result is really the only useful one to consider, since it will provide us with the key answers of how much power actually makes it into space (P_{RAD}).

Let's get started by recognizing conservation of energy:

$$P_{IN} = P_{AMP} + P_{REF} \quad (\text{Eq 20})$$

The energy that makes it to the antenna feed-point is the incident power times the cable loss:

$$P_{ANT} = A_p * P_{IN} \quad (\text{Eq 21})$$

The power radiated is given by Eq 19, with the small modification for the cable loss:

$$P_{RAD} = P_{IN} * A_p * \{1 - [(SWR - 1) / (SWR + 1)]^2\} \quad (\text{Eq 22})$$

The power reflected back to the Tuner (P_{REF}) is given by Eq 18, modified by the loss squared, since it is now a round trip (loss each way):

$$P_{REF} = P_{IN} * A_p^2 * [(SWR - 1) / (SWR + 1)]^2 \text{ (Eq 23)}$$

Now we can substitute Eq 23 into Eq 20, and solve for P_{IN} in terms of P_{AMP} , SWR and A_p (convenient, since those are values we can actually measure or are given).

$$P_{IN} = P_{AMP} + P_{IN} * A_p^2 * [(SWR - 1) / (SWR + 1)]^2 \text{ (Eq 24)}$$

Collecting the P_{IN} terms, and solving:

$$P_{IN} = P_{AMP} / \{1 - A_p^2 * [(SWR - 1) / (SWR + 1)]^2\} \text{ (Eq 25)}$$

We don't really care about the value of P_{IN} per se; it does let us calculate the antenna output, and the loss though.

Subbing Eq 25 into Eq 22, we get an expression for the power actually transmitted:

$$P_{RAD} = P_{AMP} * A_p * \{1 - [(SWR - 1) / (SWR + 1)]^2\} / \{1 - A_p^2 * [(SWR - 1) / (SWR + 1)]^2\} \text{ (Eq 26)}$$

Let's do a trio of examples to help make it concrete. We're using a 100W rig with a cable loss of 0.9 (that is, 90% of the power from the beginning of the line makes it to the end of the run, equivalent to a loss of -0.46 dB). SWR at the antenna feed-point is 3. Running the numbers, we get that the radiated power from the antenna yields 84.6W. Where did the other 15.4W go – it was lost in the feed-line to heat.

What happens if the SWR is a perfect 1 at the antenna feed-point? In that case the transmitted power is 90W. Notice that is simply the Radio power times the 0.9 loss factor of the cable. 10W goes to heat. So the SWR of 3 "penalizes" us by 5.4W compared to the SWR = 1 case.

Let's pause for a moment and consider a common misconception about antenna matching – the thought that matching will eliminate the SWR "penalty". The two cases just considered have different results, even though we had a tuner giving a perfect match. It is easy to forget that between the tuner and antenna, there will indeed be reflected waves sapping away your power (save for the perfect SWR = 1 at the antenna). You could of course mitigate this loss by putting the antenna matcher right at the antenna feed-point, and there are indeed remote tuners for that purpose.

How about a perfect cable where the cable loss factor is 1.0 (100% of the power at the beginning makes it to the end of the run)? No matter the value of SWR you use, you will transmit the full 100W. This surprising result comes about because of the Tuner – the magic it provides is to make that perfect match between Tuner and cable/antenna so that all power is transferred to the load (in this case the antenna). There are still reflected waves on the cable (unless SWR really is 1), but since there is no cable loss, everything makes it out of the antenna.

Just those few cases will help you realize that, as long as the Tuner is doing its job, you will benefit more by good cable with low loss, than fixating on getting the antenna SWR down. This is why some folks will use ladder line for long runs, since it typically has much lower loss per length.

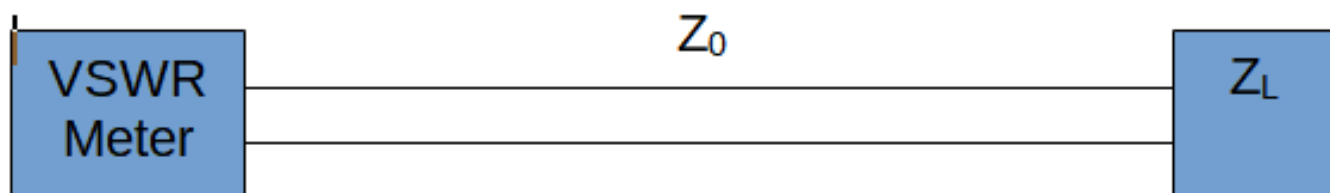
In case you need to convert a cable loss in dB to the A_p used above, the formula is simple (just remember that the value in dB will be negative):

$$A_p = 10^{(dB/10)} \text{ (Eq 27)}$$

For example, a cable run that has a -1.0 dB loss has an equivalent A_p of 0.79.

What happens when the Tuner is not doing its job (that is, the Radio/Amp now “sees” an SWR > 1)? That depends on the output stage of the Radio/Amp. There will be reflected power back to the rig’s finals - often causing the maximum voltage seen by the final output stage to be greater than when you have matched conditions. Also, it could mean less power making it into the feed-line, as the rig may either forcibly reduce power output from the high SWR, or it may just be limited to the rated output, minus the reflected portion back into the rig. Tube output stages may be more tolerant of both the voltage increase and also able to keep “pushing” the full or nearly full power even with the reflected wave. I realize there are a lot of “coulds” here, but it really does depend upon the specifics of the Radio/Amp finals.

How to Measure Cable Loss



For our final analysis, let’s figure out a way to determine cable loss by measuring SWR at the beginning of a cable, when the cable is terminated with a known impedance, and thus a known SWR at the far end. For example, we might terminate a 50Ω cable with a 250Ω resistor, to give a known SWR of 5. The analysis is not much different than what we did to determine the antenna output and cable losses.

To start, consider a V_{IN} amplitude incident signal at the start of the cable. Remember that A_p is a power ratio coefficient, so the voltage ratio will be $A_p^{1/2}$. At the terminated end, the signal will be:

$$V_{TERM} = V_{IN} * A_p^{1/2} \quad (\text{Eq 28})$$

At the terminated end, the voltage reflection coefficient will be $|\Gamma|$, which we know from Eq 17:

$$|\Gamma| = (SWR_{TERM} - 1) / (SWR_{TERM} + 1) \quad (\text{Eq 17})$$

This means the reflected wave voltage at the termination will be:

$$V_{REF-TERM} = V_{IN} * A_p^{1/2} * (SWR_{TERM} - 1) / (SWR_{TERM} + 1) \quad (\text{Eq 29})$$

As it travels back to the beginning, there is another $A_p^{1/2}$ drop in voltage, thus:

$$V_{REF} = V_{IN} * A_p^{1/2} * A_p^{1/2} * (SWR_{TERM} - 1) / (SWR_{TERM} + 1) \quad (\text{Eq 30})$$

Of course the two $A_p^{1/2}$ terms multiplied together just equal A_p . Now we have V_{IN} and V_{REF} at the beginning of the cable, and that is related to the measured SWR_{MEAS} by:

$$SWR_{MEAS} = (V_{IN} + V_{REF}) / (V_{IN} - V_{REF}) \quad (\text{Eq 31})$$

Subbing Eq 30 into Eq 31, and factoring out V_{IN} , we get:

$$SWR_{MEAS} = [1 + A_p * (SWR_{TERM} - 1) / (SWR_{TERM} + 1)] / [1 - A_p * (SWR_{TERM} - 1) / (SWR_{TERM} + 1)] \quad (\text{Eq 32})$$

Multiply both sides by the RHS denominator, and collect the A_p terms:

$$A_p * [(SWR_{TERM}-1)/(SWR_{TERM}+1) + SWR_{MEAS} * (SWR_{TERM}-1)/(SWR_{TERM}+1)] = SWR_{MEAS}-1 \quad (\text{Eq 33})$$

Isolating A_p and cleaning up:

$$A_p = [(SWR_{MEAS}-1)/(SWR_{MEAS}+1)] * [(SWR_{TERM}+1)/(SWR_{TERM}-1)] \quad (\text{Eq 34})$$

That was a little work, but a rather simple result. So, let's say you have 100ft of some old 50Ω cable. You terminate it with a 250Ω resistor at the far end, and measure the SWR at the non-terminated end. The SWR_{TERM} is 5 (250Ω / 50Ω). If you measure an SWR of 3, Eq 34 yields that A_p will be 0.75. Converting to dB (using $10 * \log_{10} [A_p]$) that would be -1.25 dB (loss).

Consider another case when you have the far end shorted, and you measure $SWR_{MEAS} = 10$. SWR_{TERM} is ∞ , so the right hand factor in Eq 34 is just 1, and A_p will be 0.82, or -0.86 dB. The challenge here is that you may not be able to readily measure an SWR that high, so using a termination resistor like the first case will help you.

What if you terminate with a 50Ω dummy load? In that case, we have a small problem in our formula, since there will be a divide by 0, as SWR_{TERM} is 1. But note, with that SWR, there is no reflection, and so the SWR at the beginning of the line will read 1 no matter what A_p is. That means we can't tell anything about the cable loss if we use a matching dummy load.

Conclusions

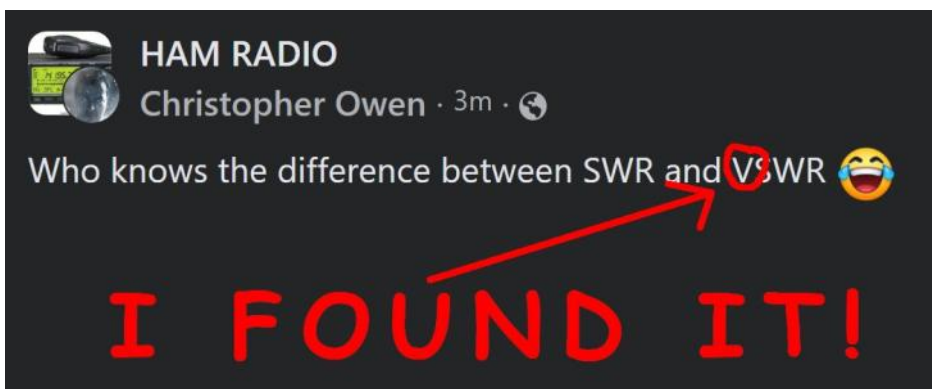
I congratulate you for making it this far – even though the math was straightforward algebra, there was a lot of it. But if you take the time to really absorb what is going on here, you'll have a far better understanding of how that formerly mysterious SWR reading really affects your setup.

SWR and cable losses conspire together to keep you from transmitting all of your precious signal, but now you have enough knowledge to figure out your best plan to measure and minimize those losses, and to characterize your cables.

As always, please do not hesitate to reach out with questions – you can contact me at kc3vnb@gmail.com.

This article is dedicated to the memory of my college advisor and mentor, Dr. David Tuma. My first class with him was "Fields, Waves and Transmission Lines".

de Brian -- KC3VNB



Coax Adapters

de Paul - AC3IE

Here's the scenario... you are out at a radio event with several fellow hams. You are on 40 meter CW but can hear someone else from your group transmitting, and it is hard to copy. See Figure 1. You mention it politely to your buddy who digs through a box of stuff and hands you a 40 meter filter and says "Here, use this." Perfect. You've been meaning to look into filters and now is your chance to see how well they work. You grab a short coax jumper and start to connect the filter in line and are faced with the situation in Figure 2.

You go back to your buddy, explain your current dilemma, and ask for help. You are given a small box with all kinds of small, mostly round doohickeys, thingamajigs and widgets as in Figure 3. Being a ham and geek in good standing, you say, "Of course, thank you. I forgot to bring mine." After a moment of puzzlement, you notice that each item will connect to one or more kinds of coax connector. You quickly figure out that you need two of the doohickeys (see Figure 4): one side connects to your cable that has a BNC connector and the other side connects to the SO-239 on the filter as shown in Figure 5. Repeat that on the other side of the filter, and you have solved a very common problem (Figure 6). And one you will remember for as long as you are a ham!

Figure 1: Your original setup.

An original QRP Labs QCX Transceiver with which you pound away on 40 meters. But it gets noisy, probably from other transmitters nearby.



Figure 2: You get a filter.

The filter will cut down on received and transmitted interference once you get it hooked up properly.



Figure 3: You get a box of doohickeys.

Apparently you can use them to connect coax with different kinds of connectors. But which ones to use?



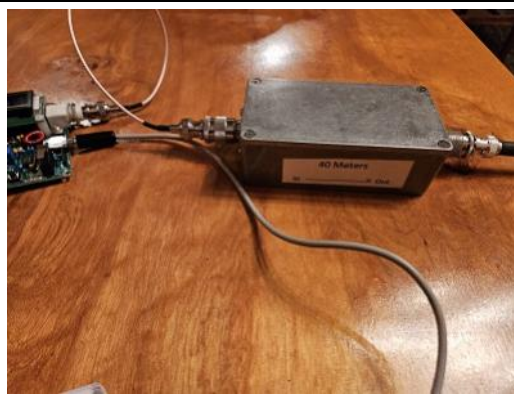
Figure 4: These look good.
Coax with BNC on one side will connect to the UHF SO-239 on the filter.



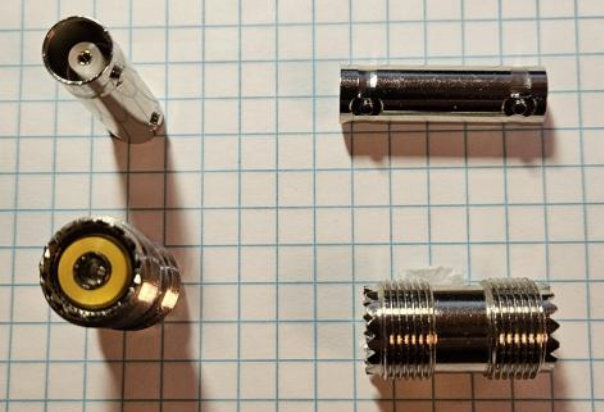



Figure 5: One side done.
Coax with BNC connects to the adapter which screws onto the filter's SO-239.



Figure 6: Both sides connected.
The filter is now in line. A lot less interference from other transmitters and fewer dirty looks from others trying to copy stations through *your* interference.



Let's dig through the box of doohickeys—no-- make that *coax adapters* and see what we have.

Barrel Connectors	
<p>BNC Barrel</p> <p>Connect two runs of coax or adapt a male BNC to female.</p>	
<p>UHF Barrel</p> <p>Connect two runs of coax or adapt a male UHF PL259 to female.</p>	
<p>BNC Male to Male</p> <p>Connect two devices with BNC Female connectors without using a short coax cable, (also called a jumper or jumper ca-</p>	
<p>UHF Male to Male</p> <p>Connect two devices with UHF SO-239 connectors without using a coax jumper.</p>	
UHF < - - > BNC adapters	
<p>UHF Male to BNC Female</p> <p>As we saw in Figures 3 - 6, they are useful for adapting coax cables with different connector types.</p>	
<p>UHF Male to BNC Male</p>	

UHF < - -> BNC adapters

UHF Female to BNC Female



UHF Female to BNC Male



Right Angle Connectors and Adapters

Right Angle Connectors

UHF Female to UHF Male
BNC Female to BNC Male



Right Angle Adapters

UHF Female to BNC Male
BNC Female to UHF Male



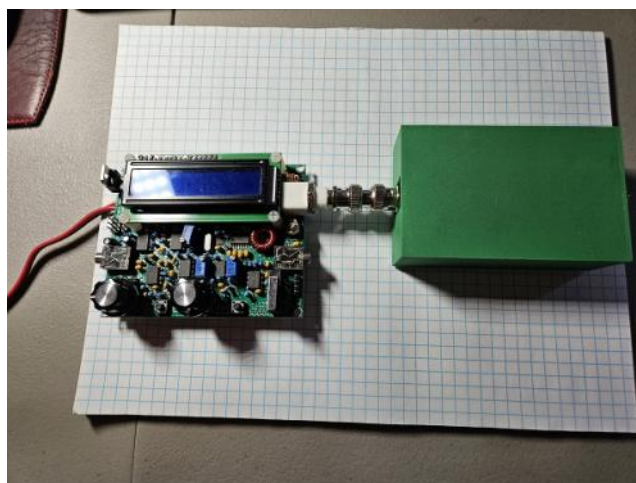
How are these used?

We can divide usage into Normal long term , Normal short term, and Field Day, POTA, SOTA

Here is an example of normal short term use. Rather than using a jumper cable to connect the low pass filter to the QRP-Labs QCX Transceiver, a Male to Male BNC is used. Words of caution, the PC Board mounted BNC connectors on the transceiver and the filter are not all that secure. Be careful when connecting and disconnecting them to avoid damage. A flexible jumper may be a better choice since it will also permit more convenient placement of the filter, if needed. Of course, if you don't have an available jumper, this makes a workable substitute.



Here is an example of normal short term use. Rather than using a jumper cable to connect the low pass filter to the QRP-Labs QCX Transceiver, a Male to Male BNC is used. Words of caution, the PC Board mounted BNC connectors on the transceiver and the filter are not all that secure. Be careful when connecting and disconnecting them to avoid damage. A flexible jumper may be a better choice since it will also permit more convenient placement of the filter, if needed. Of course, if you don't have an available jumper, this makes a workable substitute.



Here is another common short term use. You just got a new antenna up in your back yard, but the coax cable you want to use isn't long enough. You could order or make another of the right length, but you really want to try it and see how well it works right now. Make two cables into one longer one with a barrel connector. Later, you can buy or build the cable to the right length.



Here are examples of Field Day, POTA, SOTA usage. You are out in the field with several members of your club working on an antenna. George has a cable with UHF PL259 connectors. Fred uses cables with BNC connectors. Between the two of them, there is enough coax to get from the antenna to the rig, but what to do to connect the two disparate coax runs? Neither barrel connector works in this case. Sally has a good selection of coax adapters and offers a UHF Female to BNC Female which connects them easily.

Another group needs to connect two UHF cables but does not have a barrel connector. Sally is all out of UHF barrel connectors but provides two UHF female to BNC male adapters and a BNC Barrel. It looks a bit odd but the makeshift UHF Barrel will get the job done for the time required. Just be sure, she gets all the adapters back so they are available the next time.



**Adapters Adapting - K3JZD
(Radio to Tuner)**



Building Your Collection

Depending on which connectors you have on your coax cables, you will probably buy the adapters, barrels and right angles you need. Then you need more. And more. And different. And they end up all over the place. I would find them in my antenna bag, the bottom of my backpack, the cup holder in the car and in the pocket of the jacket I wore last time. I finally used a plastic bin large enough to accommodate all the kinds I had and endeavored to always put them back. Taking it out on POTA activations saved the day on more than one occasion! But I found that I didn't need that many, and the bin was inconvenient to pack. It usually just sat in the back seat and eventually opened up and disgorged its content.

Then I got a smaller "travelling bin" and put just the ones I used the most in it and a some additional items. It fit in my back pack or my coax bucket easily.

I later noticed some extra room in the Harbor Freight box that holds my POTA transceiver and a few other items. Pluck one square of foam for each adapter and shove it in. Sally will be proud of you, unless, of course, they are ones you "forgot" to give back to her.

Something to consider for your collections.

Home Bin



Travelling Bin

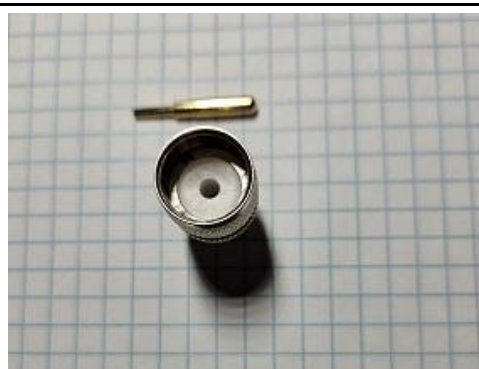


Harbor Freight Box



Buyer Beware

Are all coax connectors made to the same quality standards? No, of course not. Can you tell by looks or price? Not with enough accuracy. Here is a BNC female to UHF male with a problem: the pin came out. I connected it one day and nothing happened. No signal. Checking the adapter itself was not my first troubleshooting. I eventually noticed the dislodged pin, pulled it out of the other connector where it got stuck and shoved it back in. It worked and stayed until I removed the adapter at which time the pin came out again. I had the revelation that I just wasted a little money but a lot of time. Unfortunately, that was only one of three like it in my collection. After that first experience, I knew what to look for, especially if the PL259 goes in a little too easily. Do I remember where I bought them? No, of course not. Hamfest? Perhaps, but probably not. Buyer beware.



Last Thoughts

Have we covered all of the available adapters? Not by a long shot. A careful look at the Home Bin will reveal a set of SMA adapters. These are useful with NanoVNAs and for putting a different antenna on your HT.

The larger miscellaneous area in the bin has a UHF feed-through that is basically a longer barrel connector. This one is 1.75 inches long (~5 cm). I used it to get a cable connection from outside through a 1X4. Such feed-throughs come in many lengths and are also called bulkhead connectors. Note the larger nuts on it which are much easier to use than the little bitty ones you usually find.

There are also some stray UHF to 3/8 threaded for making verticals.

Perhaps someone can give us a tutorial on these diminutive SMA connectors and adapters. Including where to use them and why they are so blasted expensive.

de Paul - AC3IE

Save The Date : Saturday, April 27, 2024

H MS for PanCAN

Well, the snow and wind have found us for 2024, but planning is beginning for the Pancreatic Cancer Action Network (PanCan) Purple Stride event, HAMS FOR PANCAN.

This year I've decided to simplify the process and will only use Skyview as the lone station. Also, while we have used N3P in the past, it is done during a time that the "Pi Day" (3.14) folks want to use it. Those folks have been great in allowing us to use that 1x1 call sign for the one weekend, but I think it would make things easier all around to use a different one that is dormant at that time of year. More on that as time passes. I might go for a 1x2, we'll see.

So, as you know I will need a gaggle of hams to help as in the past. You who have helped in the past have been great. The responses received via QSL cards show that many of those that contacted us were appreciative of the event. We helped garner some donations for the cause as well.

Please save the date and let's see if we can break our record from last year. In fact, if your employer has a program that allows the company to donate to a 501 (c) (3) organization such as PanCan, investigate how they can submit a donation to our donation page (yet to be set up.)

One last thing. I would like to have a co-coordinator this year. I never know how I might be feeling, and it is always good to have a back up anyway. If someone would like to be considered let me know. There is a bit of planning help I'd like to have as well.

Okay, that's it for now. As time for the next Q5er will pass closely to the actual date, I'll have more showing up on the reflector and during club meetings. Thanks again to all that have helped in the past and I hope will be able to count on you and any other new hams to help this April.

73,

Rich/WQ3Q
Quack Quack





WEARSfest 2024

Westmoreland Emergency Amateur Radio Service, Inc.

Formerly the Foothills Amateur Radio Club and the Chestnut Ridge Amateur Radio Club

WEARSfest 2024

Greensburg, Pennsylvania

Saturday, March 9, 2024, 8:00AM to 1:00PM

Greensburg Masonic Center, 349 Donohoe Road, Greensburg

GPS Coordinates: N40°18'49.94" W79°29'22.82"

Talk-in on: 147.180, +.600, PL131.8

Visit the club's website for latest information: www.wc3ps.org

MAIN PRIZES

First Prize: Xiegu G90 HF 20W SDR Transceiver

Second Prize: Radioddity DB25-D Mini DMR Mobile Radio

Third Prize: Quansheng UV-K5 Walkie Talkie

Main Prize Tickets: \$5:00 each

Bulk Ticket Pricing: 3 for \$10, 7 for \$20, 15 for \$40, 35 for \$75, 75 for \$100

Door Admission Tickets: \$5.00 each

Door Admission Ticket includes: Chances to Win Door Prizes

FOR TABLE RESERVATIONS, TICKET SALES AND MORE INFORMATION, PLEASE CONTACT:

Abe (N3BAH), 412-357-0076 or Sam (KE3PO), 724-689-2096

email: wc3ps@comcast.net

Contesting 101

de Bob - WC3O

We enjoy contesting from the clubhouse. I'm always surprised at how well we do. The station up the joint is very nice, but it's tiddlywinks compared to most of our competition. Other stations that we play with often have large towers with stacked arrays on larger pieces of property. They are usually either privately run or run by a contesting club. Usually all of the operators are picked by the owner for their contesting abilities.



At Skyview we use whoever wants to give it a try, no matter their contesting prowess.

It blows my mind as to how many notable awards we have hanging on the wall. 1st place USA? REALLY?

George, N3GJ taught me years ago (Whether he knows it or not) that it is MUCH less the equipment, and MUCH more the operator that makes the score. With that in mind, I know that over the years I have worked to become a better op. In the beginning I sucked as bad as anyone else starting out. A good op always looks at what they did in this contest, and considers what they could do better in the next contest. There are MANY aspects of contesting to learn.

We always say it's F1, F2, F3 - But if you intend to do well, there is MUCH more to consider. Knowing your radio and its features. Knowing the logging software and what to do if things go wrong.

What are some of the tools built into the logging software and the best way to use them? How is propagation? What time is it? What band should I be on? Where should my beam antenna be pointed? What mults are out there and can I hear them to work them. Much more.

My attempt here is not to intimidate, but to help in picking a direction, to be a better op over time. My hopes are that folks wanting to contest will install N1MM on their computer at home.

Get it talking to their radio. Pick some contests and work them from home so that they are better prepared to perform well. Experience is the main thing you want. This DOES NOT mean that I am downing new people trying out contesting. I am not. New contesters is where old contesters come from!

In the spirit of self-improvement, the main reason for this article is I would like to see a vast improvement in log accuracy. When I submit a log after the contest the contest robot looks at the log for obvious errors. If there are obvious errors it gives me a reply email that tells me that the log is defective and lists the errors. These obvious errors are usually impossible signal reports and impossible callsigns. In other words, a signal report can't be 925 and a callsign cannot be KDLFGS.

The logging software is smart and knows this. If you try to enter something like this the software will pop up a warning window and ask if you really want to log this? YES/NO

In other words, it's time to look at your entry and see what's wrong. Don't just hit YES!

Sometimes I want to slap people's fingers with a ruler when I see them using the [Tab] key rather than the spacebar! That is how they land up putting the exchange



in the signal report. I tell them to use the spacebar. Next time I walk by, they're using the [Tab] key again... hi Maybe I'll spray them with water like a cat.

The last log I submitted (2024 RTTY Roundup) there were 13 errors that needed to be fixed before the robot would even accept the log! It's after the contest. It's late. I want to just go home! It takes lots of time to find the errors in the actual log, fix them and re-submit the log and hope the robot accepts it.

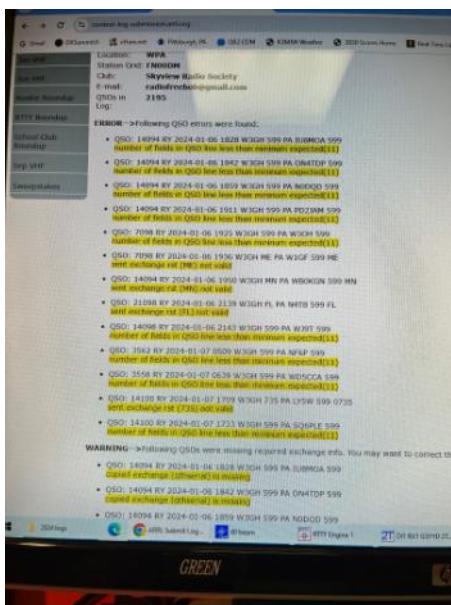
That does not include all of the other errors in the log including incorrect callsigns and exchanges. As long as I've been doing this I still make my share of mistakes. I'm not the pot calling the kettle black. We all make mistakes. The objective here is to make LESS mistakes.

After a log is submitted you can receive an LCR, a Log Check Report. The contest robot compares every QSO that you claim with everyone else's log and records the errors. In this way the robot can see who made the error.

In CW contests to see a lot of errors between 5s, Hs and Ss. (In CW that is for 5, for H and ... for S) In RTTY the error may have been caused by a weak signal of QRM. That's why it is important to look for consistency in the callsign and exchange. If the exchange comes up as 245-240, ask for a repeat. Don't just pick one and hope for the best.

Mistakes cost points. If the QSO happens to be a multiplier, it costs a lot of points! SP4HNY-SP4HN - Ask for a repeat. Look for consistency.

Marty and I have a good chuckle. We took 1st place USA recently in CQ WPX RTTY. If you check the LCR we lost over 1 million points due to log errors! Over 1 million



points! That's crazy! Just imagine what our score would have been if that error number was cut in 4! Don't think that the rest of the contest community doesn't also look at our LCR. They do. What does that say about us?

CQ WPX RTTY is right around the corner. Let's be mindful of what we are doing as we are doing it. Let's get that error number MUCH lower.

Here are some recommendations from your old uncle Bob:

- Install and play with N1MM on your own computer. Set it up. Use it in a contest. There are contests every weekend, and during the week. You'll have questions. Research them yourself and if you can't figure it out, I'd be HAPPY to help you. If you only play with N1MM a couple times a year I assure you, you'll never ever learn to use it correctly. If you want I'll send you the macros that we use up the joint. Or, develop your own. N1MM has default macros for various contests. Personally I don't like them, but you may?

- Participate in contests from your own station. You don't need to be serious about the contest or run it the entire time. Just the experience alone is priceless.

- ARRL puts out the National Contest Journal. TONS of good information. Oftentimes Bill, N3WMC brings his old NCJs up to the joint for others to read. Feel free to take them. - Get on the email list from regular contesting clubs such as PVRC or YCCC. Great info to be had.

- YouTube. Oh yeah

I know I don't want to be a mediocre contester. I know that I'll likely never be a great contester. I know some great testers and I know that I'm not them, yet.

But do you really want to be so-so all of your contesting career? There is always room for improvement. Put a little time into it.

In the meantime we have some very impressive award plaques hanging on the wall up the joint. How we got them just blows my mind! Hihi

Improve !!! — Cooky

Ultra PicoKeyer Issues

de Dan - NM3A

A few years ago, Skyview had a Smoke and Solder project building Ultra PicoKeyers (UPKs) from Ham Gadgets



UPKs are a neat small project that ends up with a very functional keyer. It's main use is for rigs that don't have a built in keyer. Most newer rigs do have built in memory keyers, so this is not usually used for them. However, some of the newer radios have menu systems that require you to access the menu to change keyer speeds or even to send memorized sequences, such as CQ. Other rigs have keyers, but no memories. For these transceivers, an external keyer with a speed potentiometer and dedicated memory buttons, the UPK is a nice, inexpensive add-on.

Another use for the UPK is to send CW over voice modes, especially VHF and UHF FM radios. It has a setting called MCW or Modulated CW. In this mode, the output to the transceiver acts as a PTT, while the audio out is sent to the microphone jack. This is a great way to use a local FM repeater for Morse Code practice.

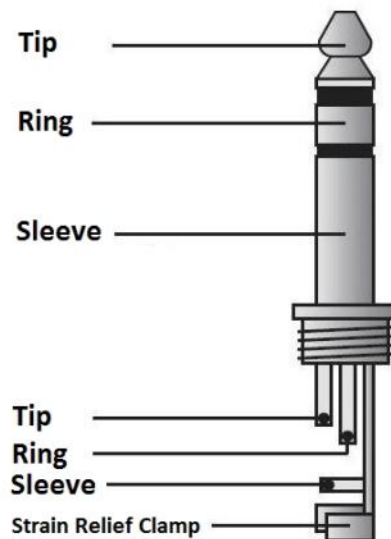
And another common use for the UPK, or any keyer, is to use it as a local practice unit to bone up on your CW sending skills with practice words or pangrams, such as "The quick brown fox ...". It has a rather low volume, high pitched internal sound transducer, but it does work and many find it a good way to increase their skill with iambic paddle sending.

The UPK runs on a PIC processor which uses very low current and has an automatic ultra low current standby mode. This means that the 2032 lithium coin cell lasts a

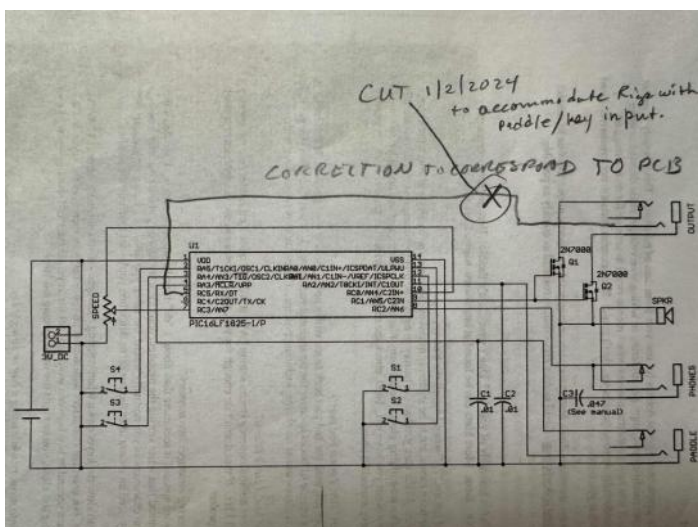
very long time - many months to years, depending on use. Alternatively, it can be powered by an external 3 volt DC supply, so it can be built into a rig. Ham Gadgets also sells the PicoKeyer-Plus which has similar functionality, but no built in buttons or speed pot. The buttons and pot can be built into the rig easily and thus is the preferred way to add a keyer to a home built transmitter project.

As mentioned above, the UPK is not normally used for rigs with internal keyers. However, recently, one ham (Charlie) wanted to use his UPK with his Elecraft K2 (the same one as Skyview's QRP Go-Kit). Now the K2 has a very nice built in keyer with nine memories and a nice, separate speed control. However, sending a message takes two button pushes and he wished to make it a bit easier on himself, so he tried to marry the UPK to his K2.

What Charlie found was that the UPK constantly keyed the K2 whenever it was connected. On contacting Radio Dan of Ham Gadgets, he found that there was an undocumented connection to the Ring on the TRS (Tip Ring Sleeve) output jack



This Ring connection is ignored and of no consequence with rigs with a simple key jack. However, with rigs that use a TRS jack for both paddles and straight key jack, this is a problem! Testing showed that many rigs with similar inputs showed constant key down when the UPK was hooked up to the rig using a TRS to TRS cable. Radio Dan suggested cutting this connection to the Ring of the output jack, as it has no current or future planned function.



I tested my two UPKs and noted that they indeed gave key down when connected to the following rigs: QCX, QMX, K2 and KX2. Others noted that it also abnormally keyed the KX3 and a few other rigs with the same type of paddle/key jack input. Not tested, but may show a similar issue, are the IC-7300, FT857D, etc., which have the same type of paddle/key combo jack. Rigs with separate straight key inputs, such as the Elecraft K3, K4, and IC-7610, as well as older rigs with no internal keyers, have no issues with the UPK as is.

After cutting the offending trace on my UPK's PCB, the UPK keyed all of the above radios with no problems. However, Charlie (remember him?) found that cutting this trace made no difference on his QCX, QMX, K2, and KX2! But his UPK did key other radios without keyers with no problem. I suggested he make up a cable with just TS on the UPK side with TRS on the radio side with just T-T and S-S connections and with no connection to the R on the radio end. Charlie did this, but his issue remained.

Charlie sent his UPK to me for trouble shooting. Swapping processors with my working UPK showed the same symptoms on his UPK PCB, but none on my UPK PCB. This pointed to an issue not directly related to the processor. I removed and tested the



2N7000 FET output transistors and found one of them was non-functional with a short in the transistor.



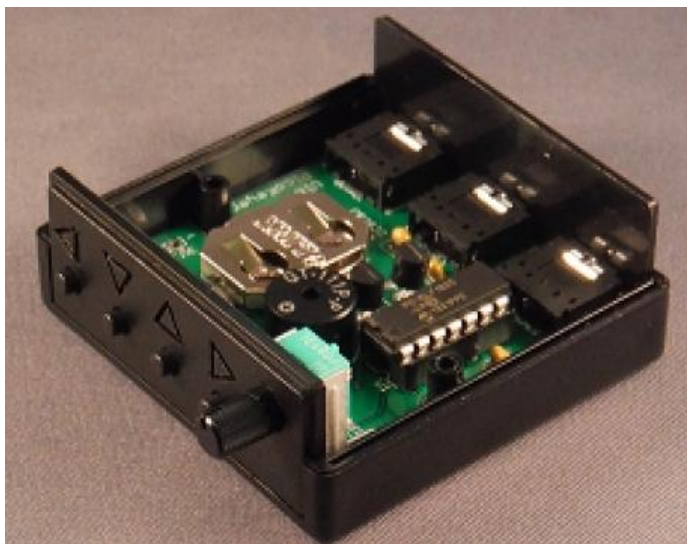
Replacing them with good FETs, restored the expected normal operation of Charlie's UPK. Unfortunately, this was not the only problem with his UPK. His PIC processor worked, but not normally. Speed control and memory function were essentially not useable. Fortunately, Ham Gadgets worked with him to replace the dysfunctional PIC processor.

What happened to Charlie's UPK? Not clear, but since there were two separate active devices with dysfunctionality, most likely suspect would be ESD (Electro Static Discharge) issues. This can easily happen when putting together a kit. Walking across a carpet or some floors or even shifting in one's seat, especially with winter dry air, can produce significant static electric potential which can destroy sensitive devices instantly.

Charlie used good practice by having a conductive mat while building, but still had issues. This may have been due to an unintentional lapse in protocol, but it also may have happened when the kit was packaged at Ham Gadgets. As there were two different defective devices, it is very unlikely for this to have been bad parts from the supplier.

Conclusion: This was an interesting sleuthing trek! It's fun to be able to trace problems and fix them logically. This was a relatively easy project to do it on, as it is a very simple circuit. Radio Dan of Ham Gadgets was responsive to my requests for info as well.

Biggest take away for those with UPKs is to open yours up and cut the trace from the Ring of the output jack to Pin 5 of the PIC processor. That way you won't be surprised in the future if it doesn't work with some future rig pairing.



Radio Dan assured me that any future PCB runs will not have this connection, but current kits still have the connection. Unfortunately, the current schematic and documentation (2017) for the keyer still do not mention this connection, nor the necessity of cutting this trace. Interestingly, this is not an issue for the PicoKeyer-Plus as it uses a different PIC processor and has no connection to the output Ring jack.

de Dan - NM3A



Welcome New Members !!

Welcome the following Skyview Radio Society Members who have joined us since publishing the December 2023 newsletter:

WU3U - Curt McCormick - Elizabeth

N3YJN - Brian Gray - Curtisville

AC3LD - Jim Palumbo - New Kensington

K3RWN - Rich Newbould - Pittsburgh 15227

Remember that something is going on up at 'the joint' every Tuesday. Sign up for the K3MJW Groups.io Reflector to get the latest news and event announcements by email.

If you are a reader who is interested in becoming a Skyview member, then go to:

<http://www.skyviewradio.net/> for information.

If you are a reader who is not yet a ham, and you are interested in becoming a ham, , then go to:

<http://www.skyviewradio.net/> for information.



Skyview Radio Society Roster as of 31 JAN 24

NM3A	WA3HGW	WO3O	KC3STV
N3AFS	KB3HPC	KC3OCA	KB3SVJ
KB3APD	K3HSE	KC3OCB	KC3TEX
NA0B	KB3HXP	KC3OCC	WV8TG
W18B	AG3I	N3OEX	N3TIN
N3BAH	AC3IE	K3OGN	N3TIR
W3BUW	KE3IF	N3OIF	W3TLN
KF3C	KC3IIO	KB3OMB	KK3TM
KA3CBA	AB3IK	KB3ORO	N3TTE
KC3CBQ	WB3IMB	NK3P	KC3TTK
W3CDW	W3IU	K3PC	AG3U
K2CI	K3JAS	K4PDF	NS3U
K3CLT	N3JLR	KC3PIM	WU3U
K3CWE	KA3JOU	K2PMD	N3UIW
K3DCG	ND9JR	KE3PO	KC3UNP
N3DRB	K3JZD	W3PRL	KC3UOM
KB3DVD	WA3KFS	KC3PSQ	W3UY
K3DWS	AC3KI	KC3PXQ	KX3V
KC2EGL	AC0KK	AC3Q	KC3VCX
KC3EJC	W4KV	NU3Q	KC3VNB
K3ELP	KC3KXZ	WQ3Q	K3VRU
AB3ER	WE3L	KC3QAA	N3VXT
WA3ERT	WA3LCY	KC3QWF	KC3VYK
N3ERW	KC3LHW	NJ3R	W3VYK
K3ES	WB3LJQ	K3RAW	N3WAV
AC3EZ	KB3LND	KC3RIL	KC3WBN
WB3FAE	K3LR	K3RMB	KC3WCJ
K3FAZ	KC3LRT	KC3RMN	K3WM
KC3FEI	AB3LS	KC3RPE	N3WMC
K3FH	KC3LZH	W3RRK	KA3WVU
K3FKI	N2MA	I2RTF	K3WWP
KC3FWD	KC3MBM	KI2RTF	N3XF
AC3GB	N3MHZ	KD3RVR	N3YJN
N2GBR	K3MJ	K3RWN	W3YNI
AC3GE	W3MLJ	KQ3S	KB3YRU
KC3GPM	K3MRN	K3SBE	W3YS
K3GT	N3MRU	WA3SCM	KB3YYC
AB3GY	KS3N	KC3SDJ	KE3Z
KC3GZW	G4NFS	KC3SKX [SK]	K3ZAU
NC3H	KB3NSH	KC3SNZ	W3ZVX
NY9H	AJ3O	KB3SOU	
WB3HFP	WC3O	K3STL	

Notes: Only Call Signs are being published. Refer to QRZ.COM for more information. (Unable to publish those without Call Signs.)

Kul - Links

Jody - K3JZD

There is lots of stuff out on the Internet... Some of it can brighten your day. Some of it can educate you.

I can't really copy and past it all in here. But, I can point you at some of it

Starting to see lots of articles on risks that can come with Generative AI. Here is one from a good source

<http://tinyurl.com/24hk3m8r>

Seductive AI Has No Limits - Here is an interesting look at the future . . .

<https://www.youtube.com/watch?v=lgwrRn1uHkg>

(who knew there were so many kinds of AI??)

Then there is this self-charging 20 year battery (ideal for your HT , SOTA Rig, POTA Rig ??)

<http://tinyurl.com/4w6tzej3>

Big Brother IS Everywhere

<http://tinyurl.com/3wm53vum>

(But watching me would be pretty boring)

I'll consider any Kul - Links that you find.

Email then to me at: K3JZD AT ARRL DOT NET

They might just end up in the next issue

Previous Issues

Previous Issues of the Q5er are available at

<http://www.nelis.net>

Next Newsletter will be **April 1, 2024**
Closing Date For Submissions : **Mar 15, 2024**

K3JZD AT ARRL DOT NET

Become Well Known Publish in the Q5er

The Q5er goes to other clubs and is available to all on our web site.

Submissions to : **K3JZD AT ARRL DOT NET**

>>>>> **WARNING** <<<<<<

An Alarm System has been installed up at the joint. Do Not go in there on your own until you learn how to disarm and rearm it.

**** Skyview VE Testing ****

For Testing Dates, See :

<http://www.arrl.org/find-an-amateur-radio-license-exam-session>

Time: Usually 8:15 AM

Location: Skyview Clubhouse Meeting Room
2335 Turkey Ridge Rd
New Kensington PA 15068-1936

Contact: Bill Dillen
(724) 882-9612

Email: bdillen@comcast.net

<http://www.skyviewradio.net/ve-tests/>

Please E-Mail or call to register!!!

While walk-ins are accepted, the exam session may be cancelled if no candidates are scheduled.

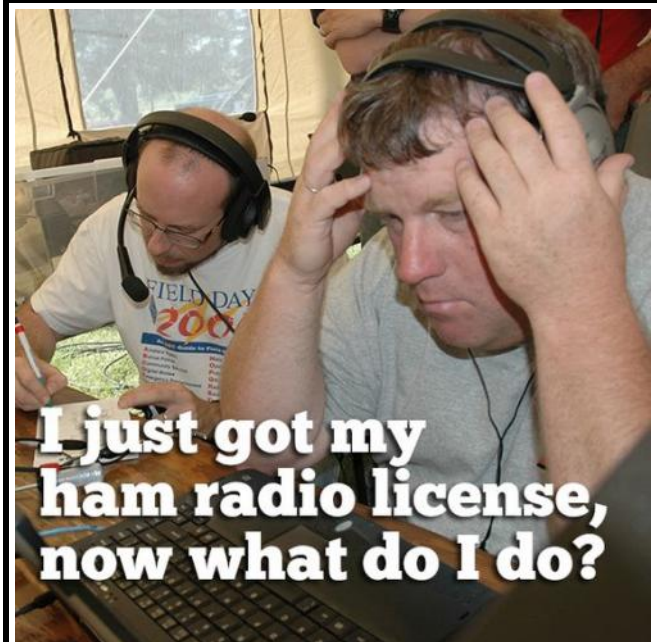


Q5er Editor & Publisher: Jody Nelis - K3JZD

This newsletter may be freely forwarded.

Permission is granted to other Amateur Radio publications to reprint articles from this issue, provided the original author and "*The Skyview Q5er*" are credited.

email your comments and article submissions to: [K3JZD AT ARRL DOT NET](mailto:K3JZD@ARRL.NET)



I just got my ham radio license, now what do I do?

That's Easy

Come up to the Skyview Clubhouse on any Tuesday and ask !!!

And See : <https://tinyurl.com/y79tqsr8>

All General Information about the Skyview Radio Society is at <http://www.skyviewradio.net>

Subscribe to K3MJW [groups.io](https://groups.io/g/K3MJW) reflector for All Current News & Activities : <https://groups.io/g/K3MJW>
If you want to keep up with what is going on NOW, that is the place - have it forward msgs to your email



Is this how your dining room looks ??

Send in pictures of your Ham Shack